

Ceiling Motion Sensor Installation Guide

Procedure to Install Ceiling Motion Sensor



[Installation Guide] Ceiling Mounted Sensor

INSTALLATION

This procedure shows you how to install a Ceiling Mounted Sensor.

Complete the following steps to correctly install the Ceiling Mounted Sensor:

1. Install batteries.
2. Pair Sensor with Room Controller. Refer to Pairing VT8000 Series Room Controller with ZigBee Sensors.
3. Verify sensing motion.
4. Install Sensor to ceiling surface.

Location

Always consider the following location constraints before installing Ceiling Mounted Sensor:

1. Do not install on outside wall.
2. Do not install in areas with direct heat source.
3. Do not install near any air discharge grill.
4. Do not install in areas exposed to direct sunlight.
5. Ensure ceiling surface is flat and clean.

Sensor Placement

The below illustration shows suggested placement guidelines to install Ceiling Motion Sensor to optimize detection zones.

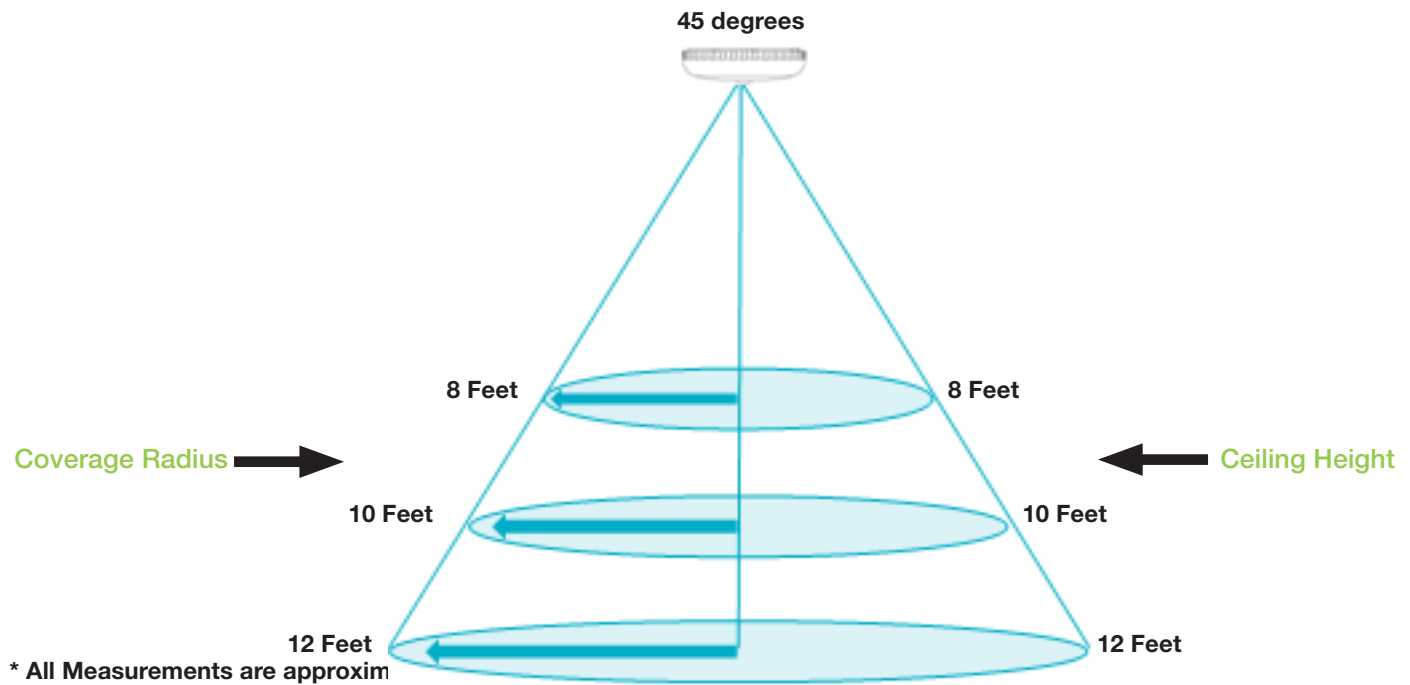

INSTALL BATTERIES

1. Remove Mounting Plate by rotating Housing counter-clockwise (Figure 1).
2. Install two AAA batteries in Sensor Housing (Figure 2).
NOTE: ensure battery polarity is correct.
NOTE: When batteries are first installed, the sensor automatically goes into pairing mode. Refer to the Room Controller pairing procedure for commissioning.
3. Replace Mounting Plate by rotating Housing clockwise.
4. Verify sensing motion. Refer to "Verify Sensing Motion" on page 3.

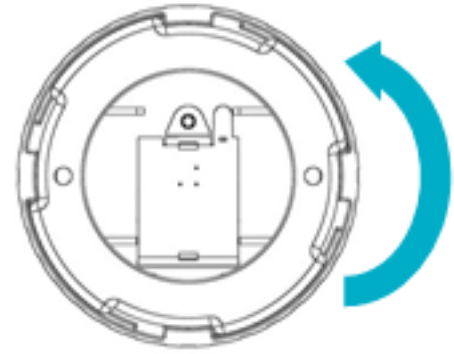

Figure - 1

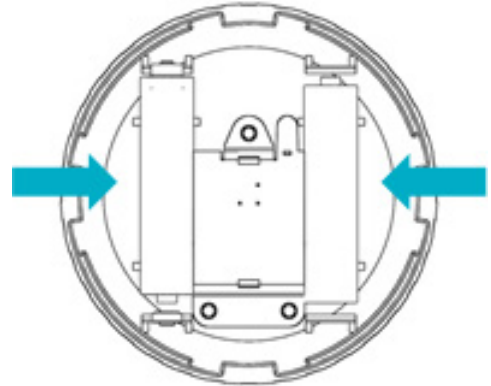

Figure - 2

VERIFY SENSING MOTION

1. Allow three minutes to pass for Sensor to warm-up.
NOTE: Sensor requires a three minute warm-up time before it reports any motion detection.
2. Wave hand or object over top area of Sensor.
3. Verify LED flashes red on Sensor (Figure 3).
NOTE: LED flashing red indicates motion detected.
4. Install Ceiling Motion Sensor to ceiling. Refer to "Install Ceiling Motion Sensor" on page 4.

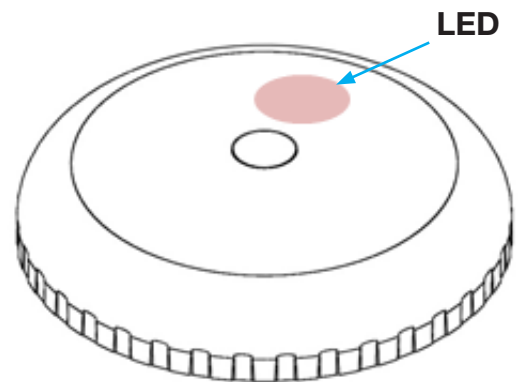
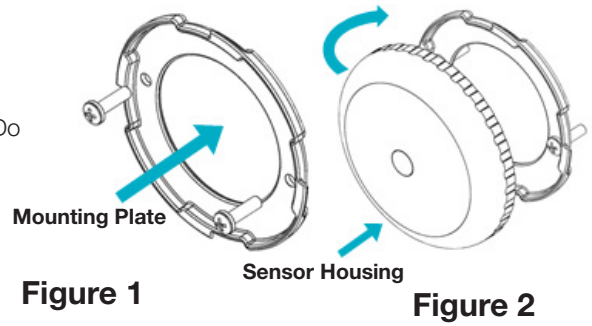



Figure 3

INSTALL CEILING MOTION SENSOR

1. Observe Sensor placement conditions before you install Sensor. Refer to "Sensor Placement" on page 2.
2. Secure Mounting Plate to overhead surface with two screws (Figure 1).
NOTE: ensure screws are tight and Mounting Plate does not move easily. Do not torque screws.
3. Set Sensor Housing assembly on Mounting Plate (Figure 2).
4. Rotate Sensor Housing assembly clockwise until it locks in place.
NOTE: ensure Sensor Housing assembly fits snugly to Mounting Plate.
5. Test Ceiling Motion Sensor. Refer to "Verify Sensing Motion" on page 3.



Always test Device before leaving job site.
Avoid installing Device directly on metal surfaces. Installation on metal can reduce transmission range.
Ensure Device is installed in dry location away from water, moisture, and rain. 

DEVICE FUNCTION

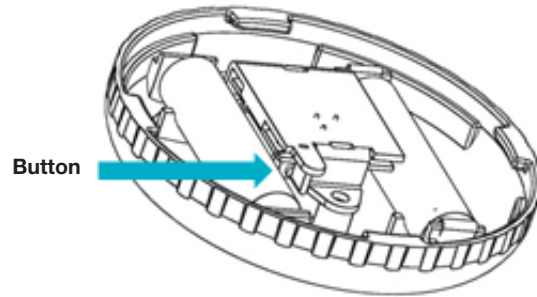
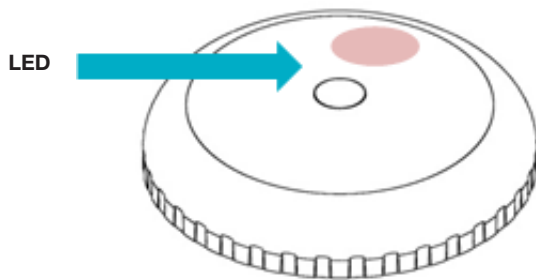

Function and LED Indicators				
BUTTON	LED	ACTION	LED	DESCRIPTION
2 times	●● GG	Network Status	●●● GGG	Joined
			●●● RRR	Not Joined
			●●● YYY	Re-Join in Process
4 Times	●●●● GGGG	Network Join	●●●● YRY	Searching for Network
			●●●● YGY	Device Being Configured
			●●●● GGG	Device Joined
			●●●● RRR	Device Failed to Join
8 Times	●●●●●●●● GGGGGGGG	Forced Re-Join	●●●● YYY	Re-Join, Searching for Parent
10 Times	●●●●●●●●●● GGGGGGGGGG	Network leave and join a new Network	●●●● RRR	Leave if Joined
			●●●●●● GGGGG	Defaults Restored
G = Green Y = Yellow R = Red		No Action	● Y	Wrong Button Press
		Power Up	●●●●●● RRYGG	Device Busy